

- VERY WIDE RANGE OF SUPPLY VOLTAGE 3 to 16V
- HIGH RECOVERED AUDIO SIGNAL (100 mV, $\Delta f = \pm 22.5$ KHz or $m = 0.3$)
- DESIGNED FOR USE WITH EXTERNAL RATIO DETECTOR OR INTERNAL QUADRATURE DETECTOR
- VERY GOOD AM SIGNAL HANDLING (1V; $m = 0.8$)
- VERY SIMPLE DC SWITCHING OF AM-FM SECTIONS
- SUITABLE FOR CAPACITANCE, VARICAP AND INDUCTIVE TUNING
- VERY LOW TWEET
- COMMON (AM-FM) FIELD STRENGTH METER OUTPUT PIN

The TDA 2220 is a high performance AM/FM radio IC designed for use in a wide range of car radio, portable radio and home radio applications, operating on a supply voltage from 3 to 16V. A special feature of this device is that it may be used with an internal quadrature detector or an external ratio detector. The TDA 2220 is supplied in a 20 pin plastic DIP package.

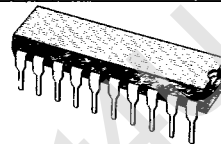

DIP-20 Plastic (0.4)

ORDERING NUMBER: TDA 2220

ABSOLUTE MAXIMUM RATINGS

V_s	Supply voltage	16	V
P_{tot}	Total power dissipation at $T_{amb} \leq 70^\circ C$	800	mW
T_{op}	Operating temperature	-40 to 85	$^\circ C$
T_{stg}, T_j	Storage and junction temperature	-55 to 150	$^\circ C$

BLOCK DIAGRAM

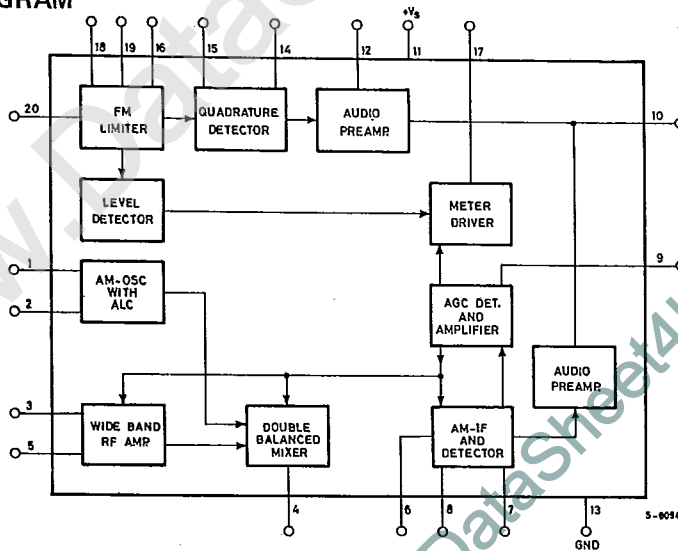

CONNECTION DIAGRAM

S G S-THOMSON

3DE D

(top view)

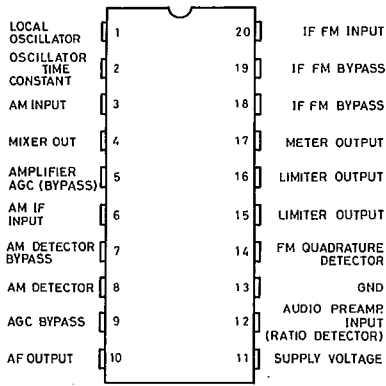

S-6093/1

THERMAL DATA

$R_{th J-amb}$	Thermal resistance junction ambient	max 100 °C/W
----------------	-------------------------------------	--------------

ELECTRICAL CHARACTERISTICS (Refer to the test circuits, $T_{amb} = 25^{\circ}\text{C}$, $V_s = 9\text{V}$, unless otherwise specified)

Parameter	Test conditions	Min.	Typ.	Max.	Unit
V_s Supply voltage		3	9	16	V
I_d Current drain	AM Section	10	16	21	mA
	FM Section	10	14	21	

AM SECTION ($f_o = 1\text{MHz}$; $f_m = 1\text{KHz}$)

V_i Input sensitivity	S/N = 26 dB	$m = 0.3$		12	25	μV
$\frac{S+N}{N}$ Signal to noise ratio	$V_i = 10\text{mV}$	$m = 0.3$	45			dB
V_i AGC range	$\Delta V_{out} = 10\text{dB}$	$m = 0.8$	100			dB
V_o Recovered audio signal (pin 10)	$V_i = 1\text{mV}$	$m = 0.3$	75	120	170	mV
d Distortion				0.5		%
d Distortion	$V_i = 1\text{mV}$	$m = 0.8$		2	3	%
V_H Max input signal handling capability	$m = 0.8$	$d < 10\%$	1			V
R_i Input resistance between pins 3 and 5	$m = 0$			7.5		K Ω
C_i Input capacitance between pins 3 and 5	$m = 0$			18		pF
R_o Output resistance (pin 10)			4.5	7	9.5	K Ω
Tweet 2 IF	$m = 0.3$	$V_i = 1\text{mV}$		38		dB
Tweet 3 IF				55		dB
V_m (*) Meter output	$V_i = 1\text{mV}$	$m = 0.3$		130		mV

(*) Meter resistance = 1.3 K Ω .

SGS-THOMSON

30E D

ELECTRICAL CHARACTERISTICS (Continued)

Parameter	Test conditions	Min.	Typ.	Max.	Unit
-----------	-----------------	------	------	------	------

FM SECTION ($f_o = 10.7\text{MHz}$; $f_m = 1\text{KHz}$)

(RATIO DETECTOR)

V_i	Input limiting voltage	-3 dB limiting point		25	36	μV
AMR	Amplitude modulation rejection	$\Delta f = \pm 22.5\text{KHz}$ $m = 0.3$ $V_i = 3\text{mV}$	50	60		dB
$\frac{S+N}{N}$	Signal to noise ratio	$\Delta f = \pm 22.5\text{KHz}$ $V_i = 10\text{mV}$	55	65		dB
d	Distortion	$\Delta f = \pm 75\text{KHz}$ $V_i = 1\text{mV}$		0.4	0.7	%
d	Distortion	$\Delta f = \pm 22.5\text{KHz}$ $V_i = 1\text{mV}$		0.2		%
V_o	Recovered audio signal (pin 10)	$\Delta f = \pm 22.5\text{KHz}$ $V_i = 1\text{mV}$	75	120	170	mV
R_i	Input resistance between pin 20 and ground	$\Delta f = 0$		6.5		$\text{K}\Omega$
C_i	Input capacitance between pin 20 and ground	$\Delta f = 0$		14		pF
R_o	Output resistance (pin 10)		4.5	7	9.5	$\text{K}\Omega$
$V_m^{(*)}$	Meter output	$V_i = 1\text{mV}$ $\Delta f = \pm 22.5\text{KHz}$		110		mV

FM SECTION ($f_o = 10.7\text{MHz}$; $f_m = 1\text{KHz}$)

(QUADRATURE DETECTOR)

V_i	Input limiting voltage	-3dB limiting point		25	36	μV
AMR	Amplitude modulation rejection	$\Delta f = \pm 22.5\text{KHz}$ $m = 0.3$ $V_i = 3\text{mV}$	35	44		dB
$\frac{S+N}{N}$	Signal to noise ratio	$\Delta f = \pm 22.5\text{KHz}$ $V_i = 10\text{mV}$	55	65		dB
d	Distortion	$\Delta f = \pm 75\text{KHz}$ $V_i = 1\text{mV}$		0.7	1.5	%
d	Distortion	$\Delta f = \pm 22.5\text{KHz}$ $V_i = 1\text{mV}$		0.25		%
d	Distortion (double tuned)			0.1		%
V_o	Recovered audio signal (pin 10)	$\Delta f = \pm 22.5\text{KHz}$ $V_i = 1\text{mV}$	60	90	130	mV
R_i	Input resistance between pin 20 and ground	$\Delta f = 0$		6.5		$\text{K}\Omega$
C_i	Input capacitance between pin 20 and ground	$\Delta f = 0$		14		pF
R_o	Output resistance (pin 10)		4.5	7	9.5	$\text{K}\Omega$
$V_m^{(*)}$	Meter output	$V_i = 1\text{mV}$ $\Delta f = \pm 22.5\text{KHz}$		110		mV

(*) Meter resistance = 1.3 $\text{K}\Omega$.

Fig. 1 - Test circuit with FM ratio detector

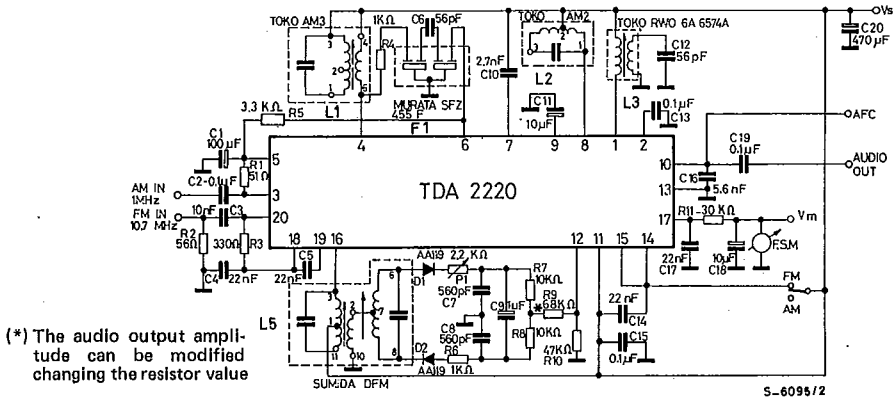
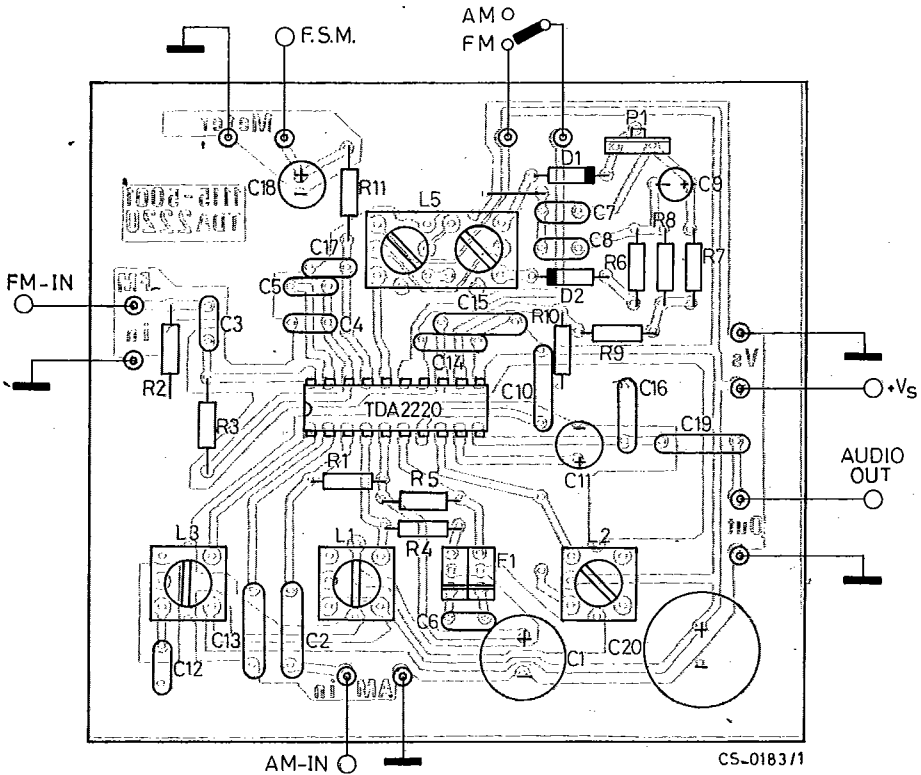

Fig. 2 - P.C. board and component layout of the circuit of fig. 1 (1:1 scale)



S G S-THOMSON

30E D

Fig. 3 - Test circuit with FM quadrature detector

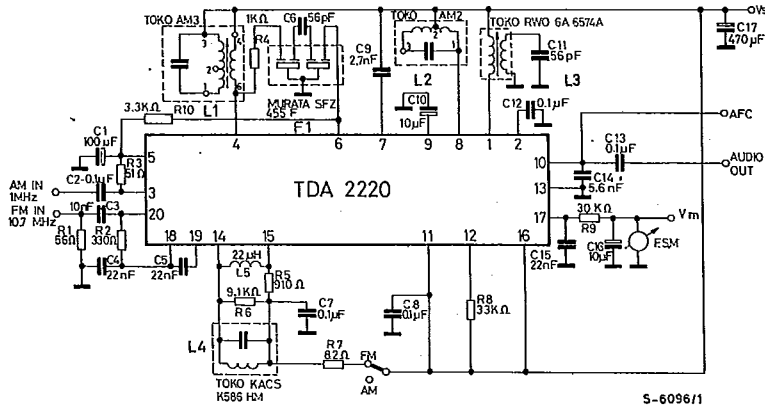
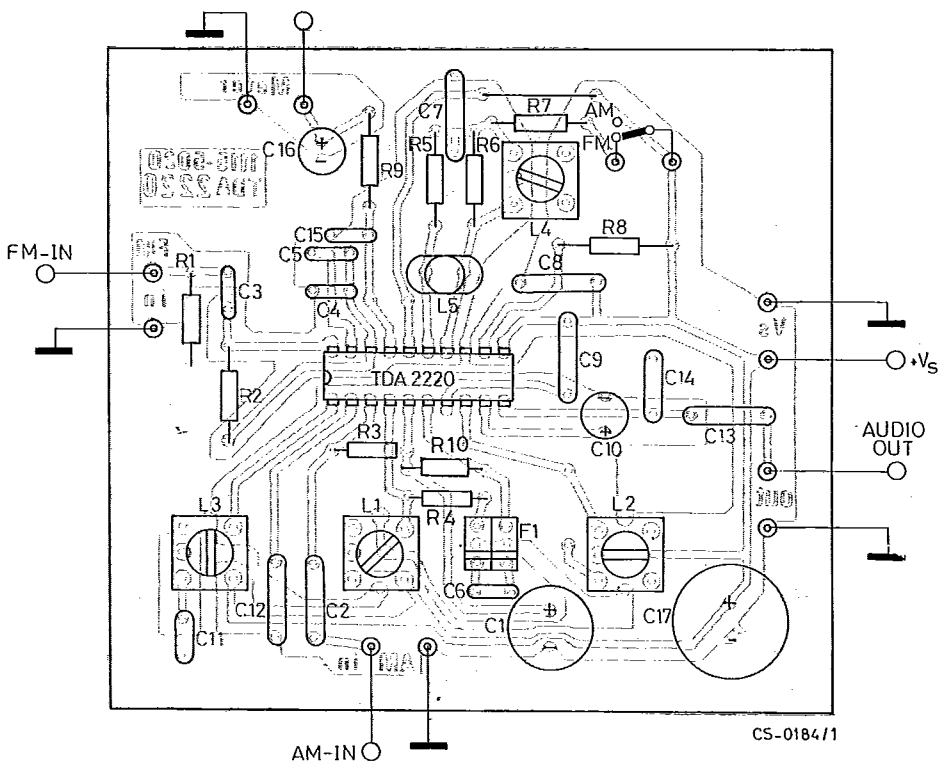

Fig. 4 - P.C. board and component layout of the circuit of fig. 3 (1:1 scale)



SGS-THOMSON

30E D

L1 - 455 kHz IF Coil

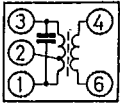

C ₀ (pF)	f (MHz)	Q ₀	TURNS		
			1-3	1-2	2-3
180	455	70	57	116	24

TOKO AM3 - 10x10 mm
RLC - 4A7525N

L2 - AM Detector Coil

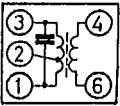

C ₀ (pF)	f (KHz)	Q ₀	TURNS		
			1-3	1-2	2-3
180	455	70	173	94	9

TOKO AM2 - 10x10 mm.
RLC - 4A7524EK

L3 - AM Oscillator Coil

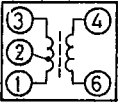

f (kHz)	L (μH)	Q ₀	TURNS		
			1-3	1-2	2-3
796	220	80	2	75	8

TOKO - 10x10 mm.
RWO - 6A6574N

L4 - FM Detector Coil

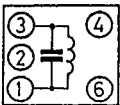

5-6097

C ₀ (pF)	f (MHz)	Q ₀	TURNS		
			1-3	1-3	1-3
82	10.7	100	12	-	-

TOKO - 10x10 mm
KACS - K586 HM

L5 - Ratio Detector

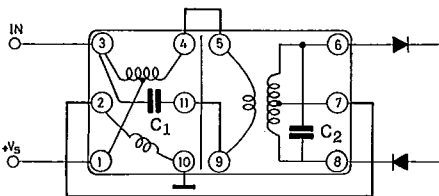

5-6098

C ₁ (pF)	C ₂ (pF)	f (MHz)	Q ₀
3-11	6-8	10.7	70
27	47		

SUMIDA
DFM

TURNS					
1-3	1-4	2-10	5-9	6-7	7-8
11	6½	5½	½	7	7

APPLICATION INFORMATION

Fig. 5 - AM/FM car radio receiver.

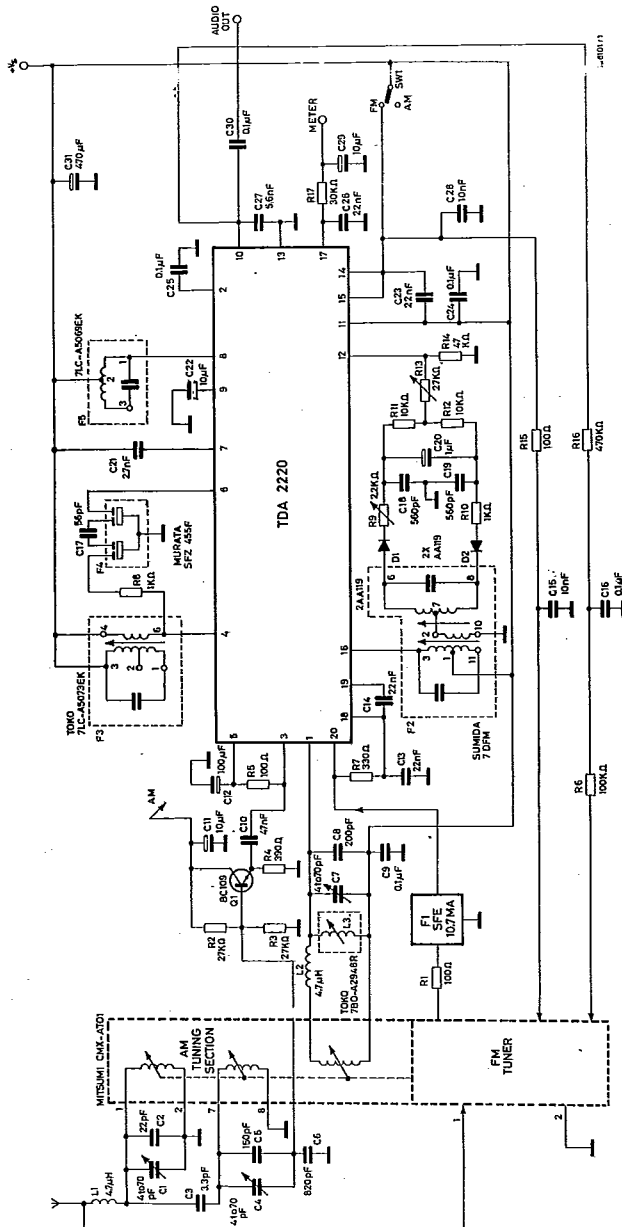

Note - The transistor Q1 can be eliminated using the tuner of fig. 7.

Fig. 6 - P.C. board and component layout of the circuit of fig. 5 (1:1 scale)

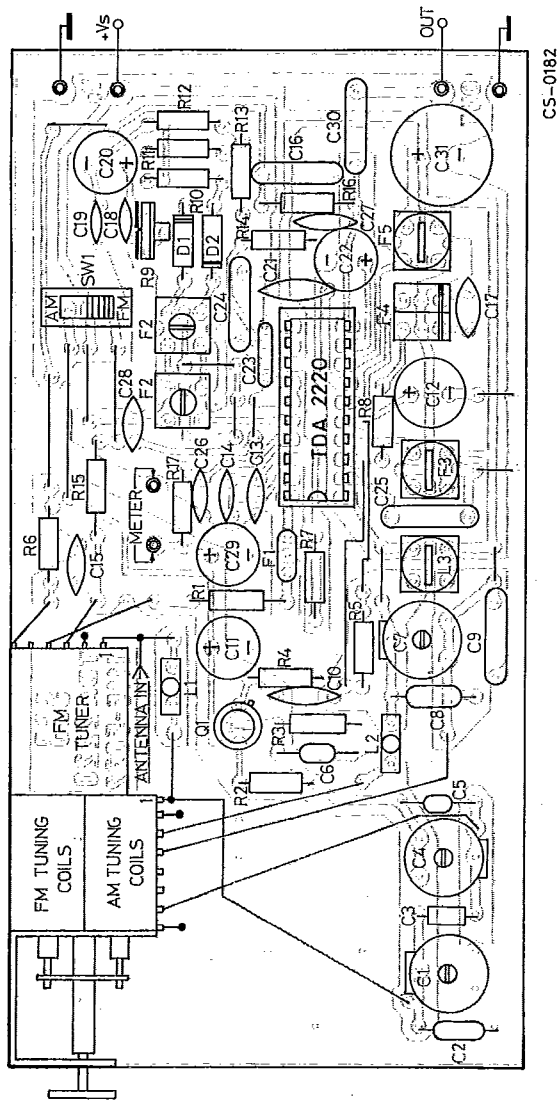

CS-0182