

MN3209

256-STAGE LOW VOLTAGE OPERATION LOW NOISE BBD

General description

The MN3209 is a 256-stage low voltage operation ($V_{DD} = 5V$) low noise BBD that provides a signal delay of up to 12.8ms and is particularly suitable as a device for generation of chorus and vibrato effects of audio equipments in low voltage operation portable stereo, radio cassette recorder and electronic musical instruments, etc.

Features

- Variable delay of audio signal: 0.64 ~ 12.8ms.
- Wide supply voltage: 4 ~ 10V.
- No insertion loss: $L_i = 0dB$ typ.
- Wide dynamic range: $S/N = 80dB$ typ.
- Low distortion: $THD = 0.4\%$ typ. ($V_i = 0.25V_{rms}$).
- Clock frequency range: 10KHz ~ 100KHz.
- N-channel silicon gate process.
- 8-lead dual-in-line plastic package.

Applications

- Sound and echo effects of audio equipment such as radio cassette recorder, car radio, portable radio, portable stereo, echo microphone and pre-taped musical accompaniments, etc.
- Sound effect in electronic musical instruments.
- Variable or fixed delay of analog signals.

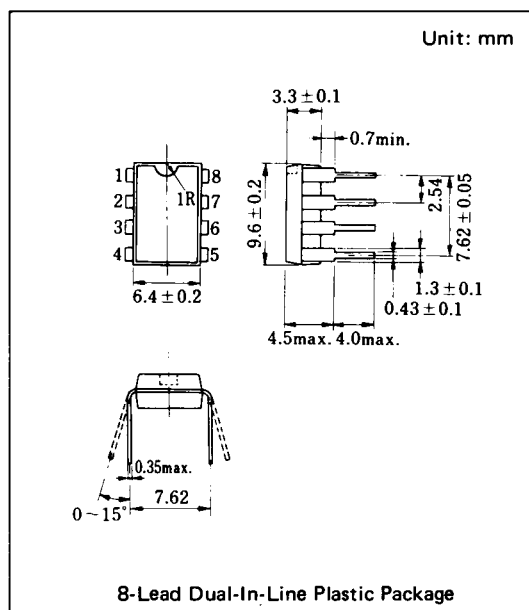

Block Diagram

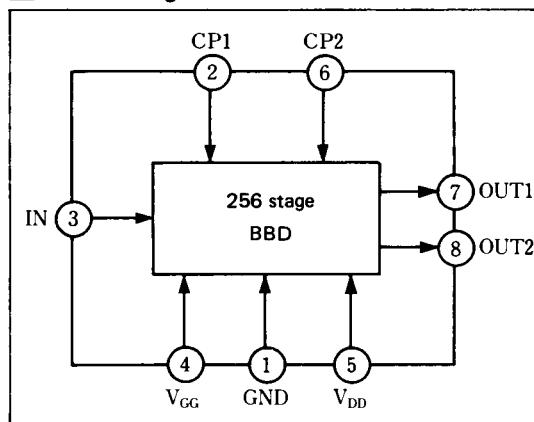

Quick Reference Data

| Item | Symbol | Value | Unit |
|---------------------------|------------------|----------------------------|------|
| Supply Voltage | V_{DD}, V_{GG} | + 5, $\frac{1}{18} V_{DD}$ | V |
| Signal Delay Time | t_D | 0.64~12.8 | ms |
| Total Harmonic Distortion | THD | 0.4 | % |
| Signal to Noise Ratio | S/N | 80 | dB |

■ Absolute Maximum Ratings (Ta = 25°C)

| Item | Symbol | Rating | Unit |
|-----------------------|--|----------|------|
| Terminal Voltage | V _{DD} , V _{GG} , V _{CP} , V _I | -0.3~+11 | V |
| Output Voltage | V _O | -0.3~+11 | V |
| Operating Temperature | T _{opr} | -20~+60 | °C |
| Storage Temperature | T _{stg} | -55~+125 | °C |

■ Operating Condition (Ta = 25°C)

| Item | Symbol | Condition | Min. | Typ. | Max. | Unit |
|-------------------------|------------------|-----------|------|-----------------------|---------------------|------|
| Drain Supply Voltage | V _{DD} | | +4 | +5 | +10 | V |
| Gate Supply Voltage | V _{GG} | | | 14/15 V _{DD} | | V |
| Clock Voltage "H" Level | V _{CPH} | | | V _{DD} | | V |
| Clock Voltage "L" Level | V _{CPL} | | 0 | | +1 | V |
| Clock Frequency | f _{CP} | | 10 | | 200 | kHz |
| Clock Pulse Width *1 | t _{CPW} | | | | 0.5T *2 | |
| Clock Rise Time *1 | t _{CPr} | | | | 500 | ns |
| Clock Fall Time *1 | t _{CPf} | | | | 500 | ns |
| Clock Input Capacitance | C _{CP} | | | | 200 | pF |
| Clock Cross Point *1 | V _X | | 0 | | 0.3V _{CPH} | V |

■ Electrical Characteristics (Ta = 25°C, V_{DD} = V_{CPH} = 5V, V_{CPL} = 0V, V_{GG} = 14/15 V, R_L = 100kΩ)

| Item | Symbol | Condition | Min. | Typ. | Max. | Unit |
|---------------------------|-----------------|--|------|------|------|-------|
| Signal Delay Time | t _D | | 0.64 | | 12.8 | ms |
| Input Signal Frequency | f _i | f _{CP} = 40kHz, Output -3dB down | 12 | | | kHz |
| Input Signal Swing | V _i | THD=2.5% | 0.5 | | | Vrms |
| Insertion Loss | L _i | f _{CP} =40kHz, f _i =1kHz | -4 | 0 | 4 | dB |
| Total Harmonic Distortion | THD | f _{CP} =40kHz, f _i =1kHz, V _i =0.25Vrms | | 0.4 | 2.5 | % |
| Noise Voltage | V _{no} | f _{CP} = 100kHz Weighted by "A" curve | | | 0.12 | mVrms |
| Signal to Noise Ratio | S/N | | | 80 | | dB |

*1 Clock Pulse Waveforms

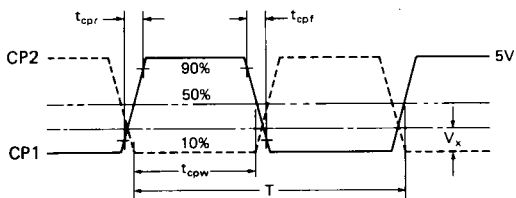

*2 T = 1/f_{CP} (Clock Period)

■ Terminal Assignments

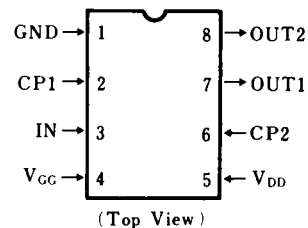

■ Circuit Diagram

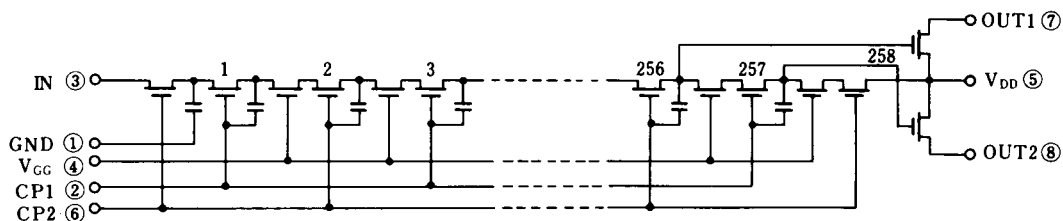

Typical Electrical Characteristic Curves

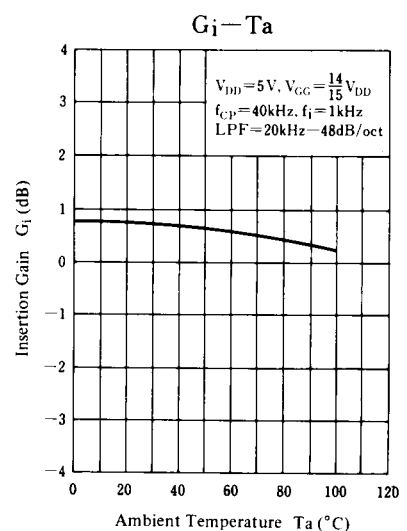
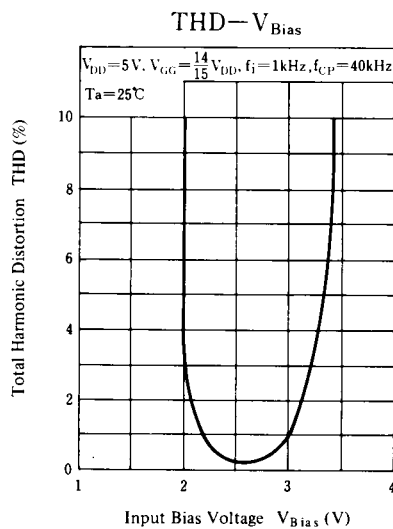
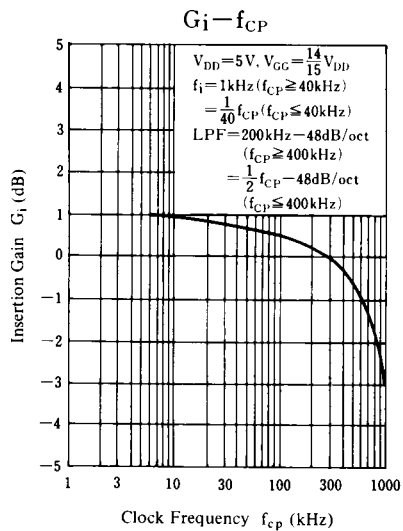
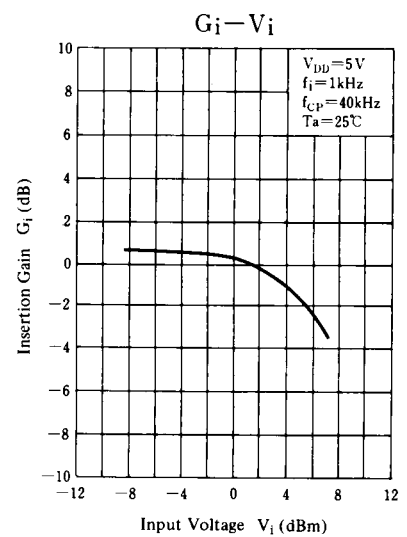
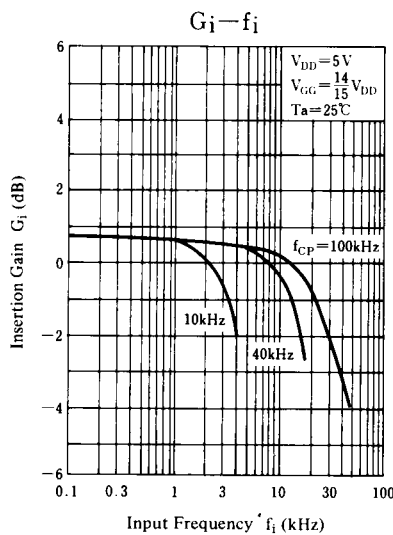
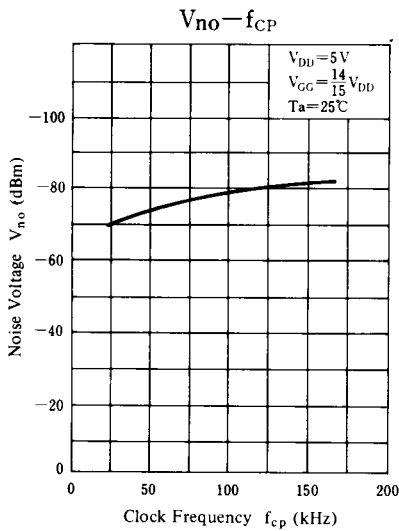
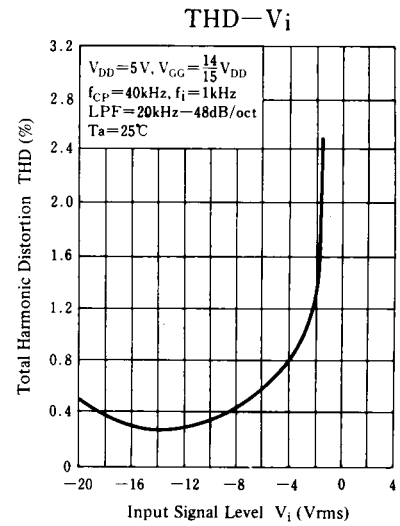
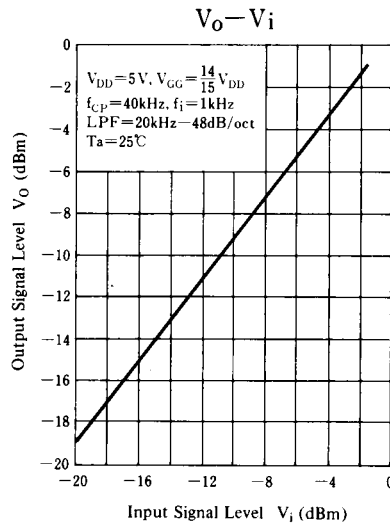
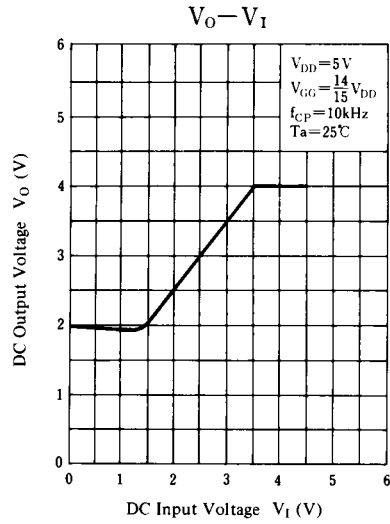

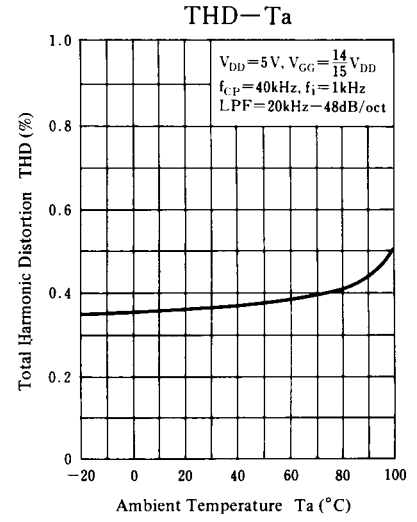
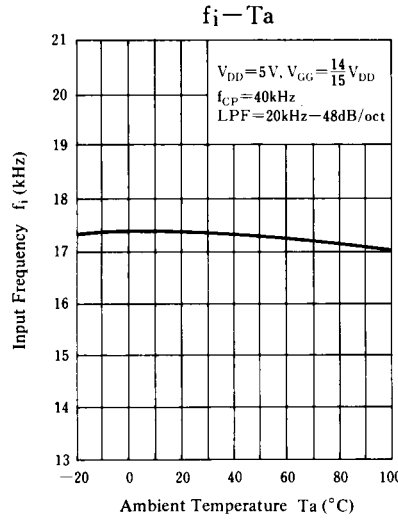
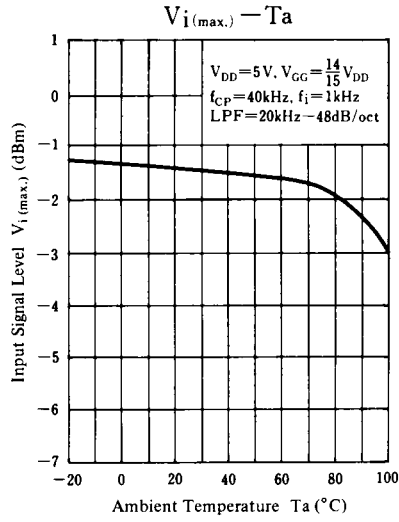

Supply Voltage Characteristics

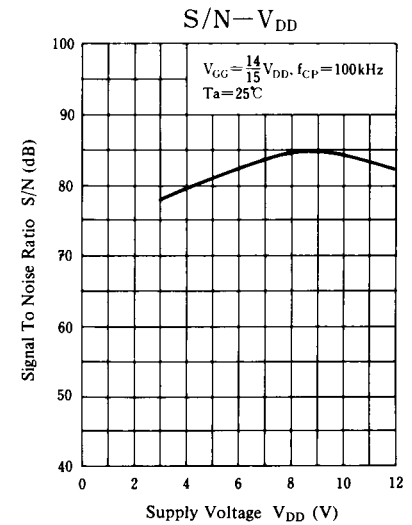
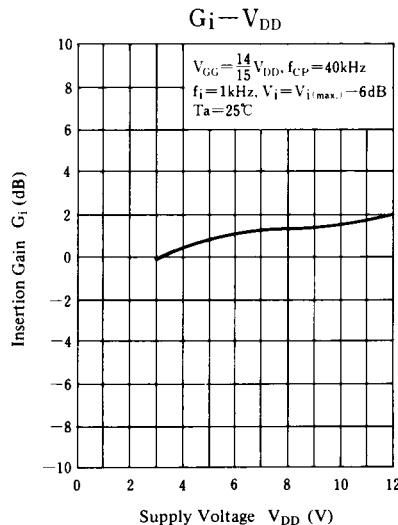
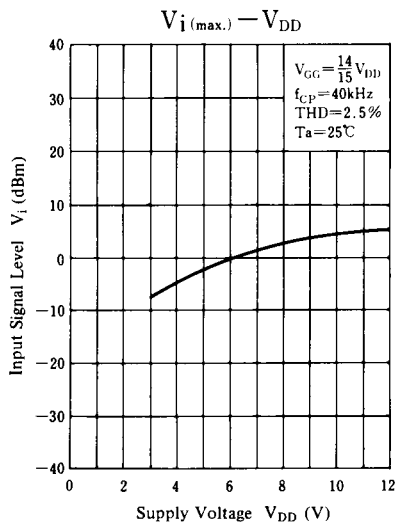
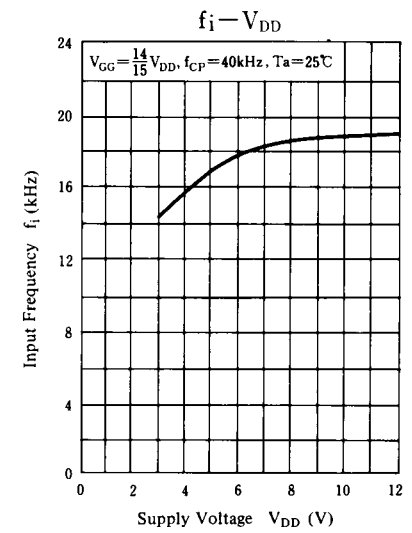
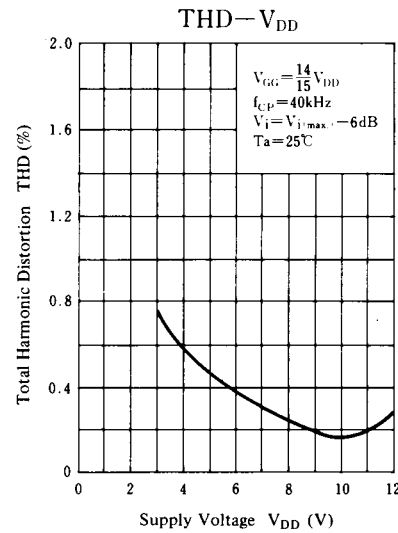
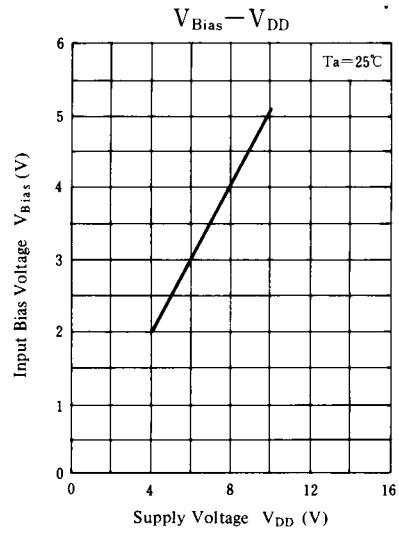

■ Application Circuit

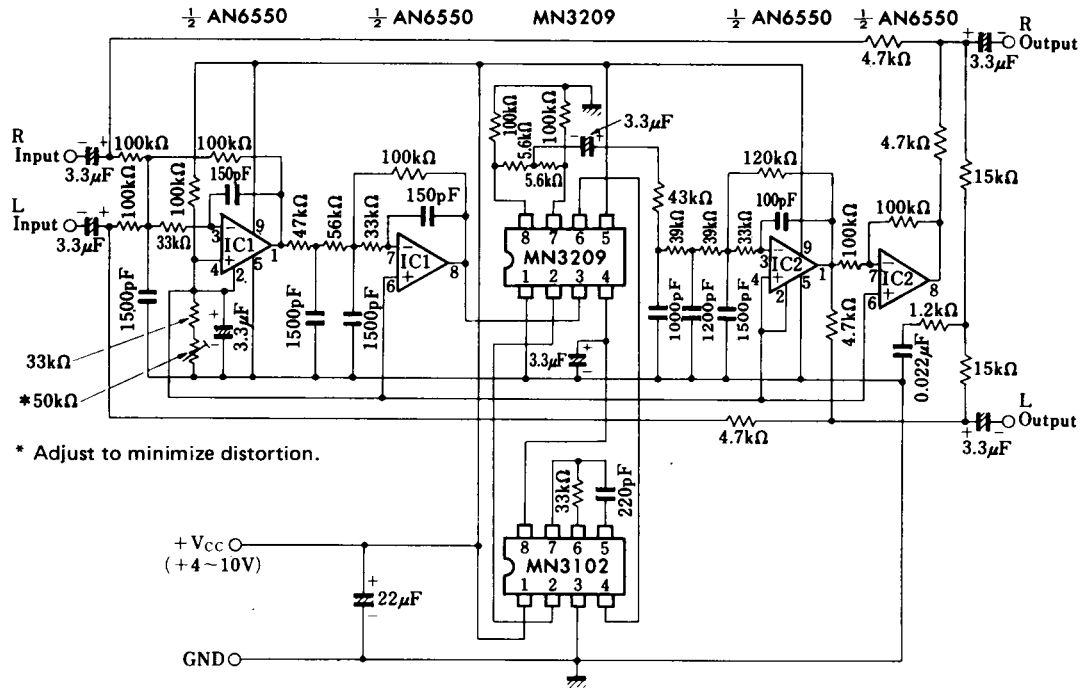

Vibrato and/or Chorus Effect Generation Circuit